

PunchLok[®] II

S Y S T E M

USER GUIDE

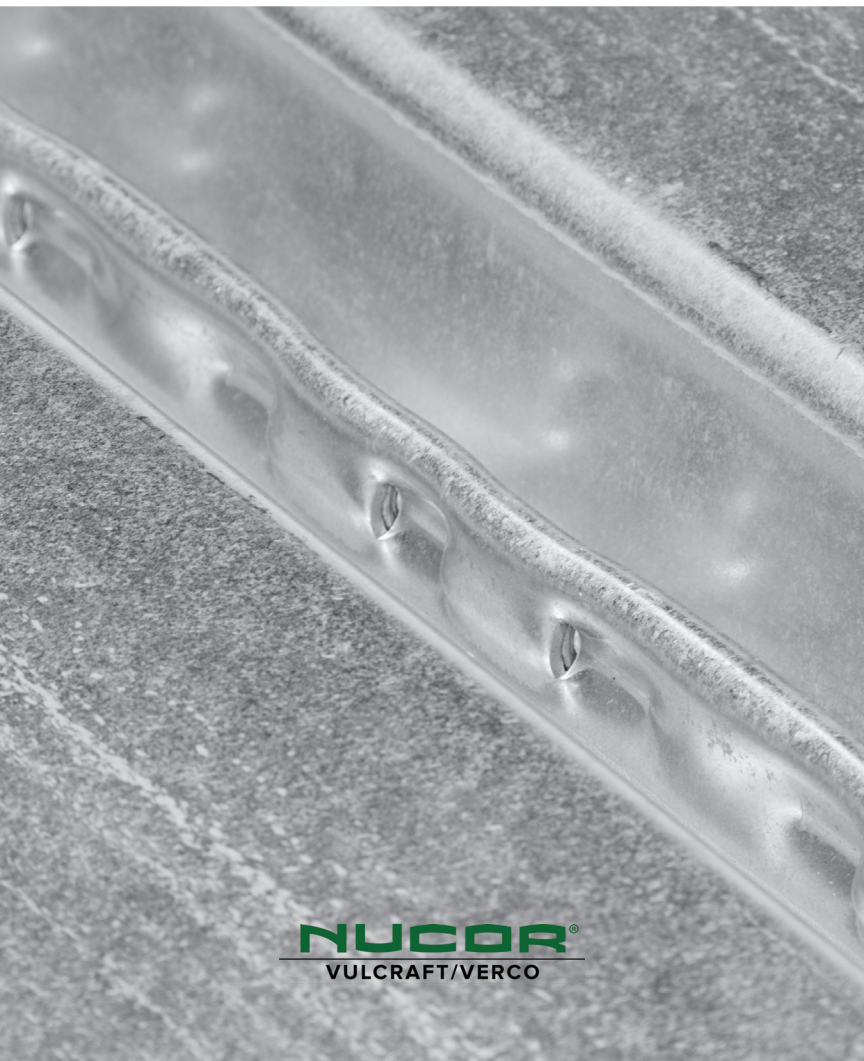

NUCOR[®]
VULCRAFT/VERCO

TABLE OF CONTENTS

Introduction	1
Safety	2
PunchLok® II System	5
PunchLok® II Tool	6
Auxiliary Equipment	8
PunchLok® II Tool Operation	12
VSC2 Inspection	15
Contact Information	16

INTRODUCTION

The PunchLok II tool is a hand-held, pneumatically-operated tool that joins sidelaps of PunchLok II system roof and floor deck.

All PunchLok II tool users (including employers of tool users and employees) must comply with all safety rules in this manual, all product guidelines for the tool and for the PunchLok II system roof and floor decks being installed, as well as with general “good practice” safety rules not included in the manual.

As with the use of any power equipment, the failure to use the PunchLok II tool in accordance with all guidelines and safety procedures may result in injury to the operator or others. Employers are responsible for enforcing compliance with all safety rules, warnings, and instructions which accompany this tool as shipped.

This manual must be available to all people who use the tool and employers shall be responsible for ensuring that employees who use the tool are aware of the proper and safe method of operation, prohibitions and restrictions on use of the tool, and the possible consequences which could result from improper use. The employer is also responsible for ensuring that individuals who use the tool are fully qualified for the task.

SAFETY

	<p>WARNING – Personal Injury!</p> <p>For personal safety, and proper operation, read and understand these instructions before operating the tool.</p>
---	--

- ✓ Read and understand all safety procedures before using the tool.
- ✓ Always use personal protective equipment including safety eyeglasses with side shields, steel toe boots, and hearing protection when using the tool.
- ✓ Always stay alert and use common sense when operating a powered tool. Do not use the tool if you are tired or under the influence of drugs, alcohol, or medication. Avoid distractions and other people who may be distracting you while operating the tool.
- ✓ Always keep hands and body parts away from actuator arms, blades or other moving parts to avoid possible injury during operation.
- ✓ Always keep tool blades pointed away from you, others, and obstructions when connecting air to the tool.
- ✓ Never use a tool, air hose, or other equipment that leaks air or needs repair.
- ✓ Always remove finger from trigger when not in operation.

SAFETY (CONTINUED)

- ✓ Always assume the tool is connected to an air source and can be activated. Keep the tool pointed away from you and others. NO horse play. Respect the tool and others working around you.
- ✓ Use the tool as intended. Do not use the tool as a welding clamp, hammer, pry bar, or for any other purpose for which it was not designed.
- ✓ Never use oxygen, carbon dioxide, or any other bottled gas as a power source for this tool; the tool may explode and cause injury.
- ✓ Use the tool only for attaching approved Verco and Vulcraft products and only in accordance with installation guidelines for the tool and those products. Do not use on other surfaces or materials.
- ✓ Do not use the tool over other areas such as end laps, welds or weld splatter, pins, or shear studs.
- ✓ Always place yourself in a firmly balanced and secured position when using or handling the tool. Never use the tool in unauthorized areas or contrary to guidelines and instructions for use of the tool or for the PunchLok II system roof and floor decks being installed.
- ✓ Never force the tool or use improper pressures, procedures or equipment.
- ✓ Be aware of your position. Do not use on unsecured material.
- ✓ When using the tool on elevated surfaces, all fall protection or restraining requirements must be followed and utilized.

SAFETY (CONTINUED)

- ✓ Disconnect air from the tool before lubricating; leaving the work area, moving the tool to another location, or handling the tool in a manner not associated with installation of PunchLok II system roof and floor decks.
- ✓ Do not wear loose fitting or flowing clothes while using the tool.
- ✓ Make sure all bolts, nuts or hoses are properly connected prior to use. Inspect the tool for free movements of components. Never use the tool if parts are missing or the tool is not functioning properly.
- ✓ All tools must be placed in a secure and safe area when not in use such that any unauthorized or untrained persons cannot use or operate the tool.
- ✓ Never modify, change, adjust or tamper with the tool. For concerns relating to the operation and/or functions of the tool, notify your Verco or Vulcraft representative prior to using the tool.

PUNCHLOK® II SYSTEM

When used properly, the PunchLok II tool creates a positive connection between the male and female lips (edges) of the deck by first clinching the sheets together, then shearing between the 3 buttress jaws with 2 cutting jaws. The 2 cutting jaws then permanently offset the male and female layers of material. The connection made by the PunchLok II tool is referred to as a VSC2 (Verco or Vulcraft Sidelap Connection 2).

The PunchLok II system has been designed and tested to connect the sidelaps of these products, securing them from vertical and horizontal movement. The PunchLok II tool is to be used only on the following properly labeled PunchLok decks:

VERCO® DECKING

Roof Deck: PLB, PLN3, PLN and all related cellular and acoustic deck profiles.

Floor Deck: PLB FORMLOK, PLN3 FORMLOK, PLN FORMLOK, PLW2 FORMLOK, PLW3 FORMLOK and all related cellular and acoustic deck profiles.

VULCRAFT® DECKING

Roof Deck: 1.5PLB, 3.0PLN and all related cellular deck profiles.

Floor Deck: 1.5PLVLI, 2.0PLVLI, 3.0PLVLI and all related cellular and acoustic deck profiles.

The design of the PunchLok II system maximizes the speed and efficiency of deck installation. Many factors can affect the speed and efficiency of deck installation, including:

- ◆ Properly trained and safe operators.
- ◆ Proper equipment that is maintained and in good working condition.
- ◆ Job site conditions.
- ◆ Weather related conditions.
- ◆ Do not use the tool on other surfaces or materials or contrary to the guidelines in this User Guide. The tool is only intended for making sidelap connections.

PUNCHLOK® II TOOL

The PunchLok II tool has been manufactured by Verco Decking, Inc. exclusively for use with the Verco and Vulcraft PunchLok II system. It weighs approximately 50 pounds and is 38" tall, 17" wide (handles) and 10" deep (air pod).

The air pod has a pressure relief valve. This is a safety mechanism that will not allow the tool to operate safely above required pounds per square inch (psi). If the air pod pressure is higher than the allowable psi, the pressure relief valve releases the excess pressure. *Do not remove or tamper with the valve.*

Note: The tool is manufactured and tested for making sidelap connections only on properly labeled Verco Decking, Inc. and Vulcraft deck panels.

PUNCHLOK® II TOOL COMPONENTS

1. Trigger Control Valve
2. 3/8" Diameter Male Air Hose Fitting
3. Tool Frame
4. Air Hose
5. Quick Exhaust Valve
6. Exhaust Muffler
7. Pressure Relief Valve
8. Air Pod
9. Clevis Assembly
10. Jaw Linkage
11. Jaw Linkage
12. Jaw Blades
13. Jaw Blades

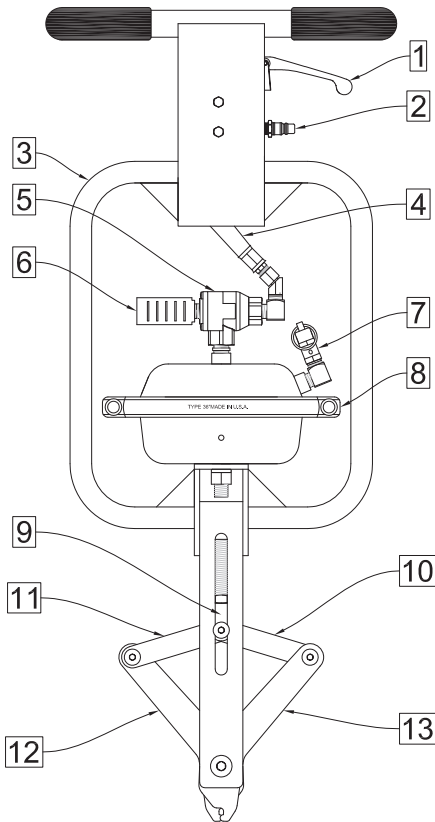

AUXILIARY EQUIPMENT

The PunchLok II tool is to be operated only with clean, dry, regulated compressed air delivered at the recommended pressure. Performance of the tool depends on selection, maintenance, and use of the equipment identified in this section while following proper safety and operating procedures. Neither Verco nor Vulcraft are responsible for problems arising from the tool operator's choice of auxiliary equipment or failure to use auxiliary equipment properly. The following considerations are not intended to be an exhaustive list, and the tool operator must independently determine whether other considerations apply to the choice and use of auxiliary equipment.

AIR COMPRESSOR

The tool's cycle time is directly related to the volume rating (cfm) of the air compressor at the operating pressure (psi), stated as cfm @ psi.

Note that the air pressure measured at the air compressor may be greater than the air pressure measured at the tool. This loss of pressure is typically caused by several factors, including:

- ◆ Length of air hose
- ◆ Air hose diameter
- ◆ Splices or leaks in air hose
- ◆ Leaks at hose connections

Tool production rates depend on the operator as well as the compressor and gage of deck. Setup time, breaks and lunches, job conditions, and weather will affect the overall daily production rate of the PunchLok II tool.

Air compressors with a maximum pressure of 175 psi and a volume rating of 25 cfm have been successfully used, handling many jobsite conditions.

The recommended minimum air pressure required at the tool is as follows for the appropriate deck gage:

Deck Gage	Minimum Pressure @ Tool
22 ga.	40 psi
20 ga.	50 psi
18 ga.	70 psi
16 ga.	90 psi

The air compressor tank must be of sufficient size to carry a reserve at all times so the compressor is operating within its rated duty cycle. Tool operators are responsible for ensuring that the compressor tank is adequately sized.

In cold weather, an air dryer may be required on the compressor to inhibit condensation in the air hose which may cause freezing at the tool's exhaust valve.

Air compressors must be properly equipped for safe and efficient operation:

- ◆ Always ensure that air lines are fully connected before applying air pressure.
- ◆ Never disconnect safety devices on equipment or tool that allows for the operation of the tool at higher air pressures.
- ◆ Air hoses must be rated for the proper air pressure: the pressure at which the tool is operated or 150% of the maximum pressure produced by the compressor, whichever is higher.
- ◆ The compressor and auxiliary tanks must be approved, tested and/or certified as required by state law. They must be designed to carry the required operating pressure.
- ◆ All pressure regulators, bypass valves, and relief valves must be appropriate for the system and in good operating condition.
- ◆ Never operate a system with air leaks or other defects.



WARNING – Drain your tank!

Air compressor tanks and hoses should be drained daily. Condensation in the tank and hoses reduces tool performance and may cause tool damage.

AIR HOSE

Use a minimum 1/2" (inside diameter) air hose. It is recommended that the air hose have no splices as splices typically cause loss of air pressure. If air hose splices must be used, compression fittings are recommended to reduce pressure loss. The PunchLok II tool is fitted with a 3/8" quick-disconnect male compression fitting. The female fitting should be attached to the hose with a compression fitting to ensure uninterrupted air flow. Compression fittings should be used on each end of the hose that connects the tank to the tool.

AUXILIARY TANK

In some cases, the use of an auxiliary tank will optimize performance. The need for an auxiliary tank is influenced by the size of the air compressor, the length of the hose and how many tools are being powered by the same compressor. If required, select an auxiliary tank with sufficient volume to supply the tool for the intended production rate.

Note: The longer the air hose, the more the pressure will drop between the compressor and the tool.

PUNCHLOK® TOOL OPERATION

The PunchLok II tool has been designed to connect the sidelaps of specific, properly labeled VERCO and VULCRAFT deck panels as previously identified. It should never be used with other products.

PREPARATION

1. Before operating the tool, perform a visual inspection of the tool. Look for:
 - ◆ Loose bolts
 - ◆ Bent parts
 - ◆ Missing parts
 - ◆ Cracks in frame or components
 - ◆ Other equipment problems

If any defects are noted, notify Verco Decking, Inc. or Vulcraft Customer Service Department before using tool.

2. Clear work area of all tools, construction materials, and other debris.
3. Identify and eliminate any other conditions that might adversely affect the use and operation of the tool.
4. Connect air hose to the tool and ensure that the tool is receiving the proper air pressure.

MAINTENANCE

Lubricate the tool at the beginning of work shift or every 4 production hours as follows:

1. Disconnect air hose from the tool and actuate trigger 2 times to ensure there is no built up air pressure in the tool to prevent accidental activation while lubricating.
2. Lubricate at points A through D with light machine oil such as 3-In-One® Multi-Purpose Oil or Marvel Mystery Oil.
3. Clean work area and properly dispose of waste.

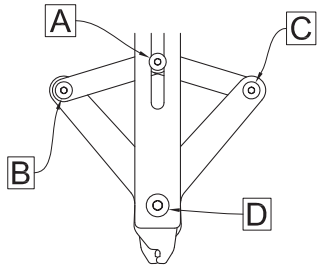

OPERATION

Important: When making VSC2 connections, be alert to your surroundings and to others working in your area.

- ✓ Never place VSC2 over end laps of deck; this will damage tool.
- ✓ Never place VSC2 adjacent to puddle welds, pins or shear studs located over supports; this will damage tool.
- ✓ Use the tool only for connecting sidelaps between supports. Never use the tool on other surfaces or materials. Doing so could result in bodily injury or damage to the tool.
- ✓ Wear proper personal protective equipment and clothing at all times.

	<p>WARNING – Tool Damage!</p> <p>Do not use or store the tool near areas where welding is being performed. Do not let the tool contact live welding rod or welding lead. Doing so will damage the tool and could result in bodily injury.</p>
---	--

CONNECTING SIDELAPS

Connect deck sidelaps with VSC2 using the following procedure:

1. Straddle deck seam and lower the tool onto deck seam area.

Note: Make sure that the male leg is fully engaged into the female leg. Distributing your body weight slightly more to the female side joint of the deck will help ensure the male leg is fully engaged.

2. Hold the tool upright and perpendicular to decking.
3. Pull and hold trigger until cutting jaws shear all three layers of metal and stop moving. Often the user will feel or hear a distinctive “click” when the punching operation is completed.
4. While releasing trigger, slightly twist the tool, this will help the jaws disengage.
5. Once disengaged, move the tool to next VSC2 location and repeat.
6. Lubricate every 4 production hours.

	<p>WARNING – Tool Damage!</p> <p>Jerking tool to free lodged cutting jaws may damage tool or decking and could cause injury to the operator and others in the area. Do not leave tool in upright position with jaws engaged in VSC2.</p>
---	---

VSC2 INSPECTION

An acceptable VSC2 has been made when the sidelap material has been sheared and offset so the sheared surface of the male leg is visible.

1. VSC2
2. Sheared surface of male leg.
3. Sheared surface of female leg.
4. Male leg / sheet
5. Female leg / sheet

Note: The VSC2 may be made from either direction.

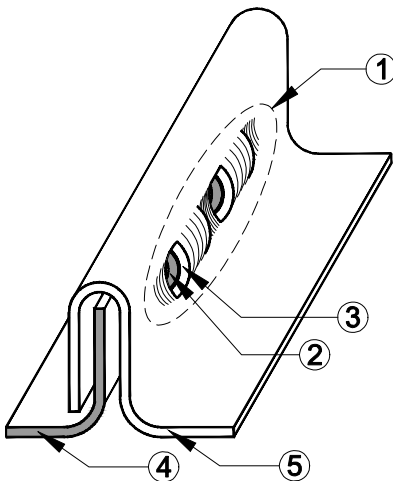

THIS MANUAL IS INTENDED SOLELY FOR INSTRUCTIONAL PURPOSES. NO WARRANTIES, EITHER EXPRESSED OR IMPLIED ARE INTENDED TO ARISE OUT OF THIS MANUAL. USE OF THE PUNCHLOK® II TOOL IS SUBJECT TO THE TERMS AND CONDITIONS OF THE THEN CURRENT PUNCHLOK® II TOOL SECURITY AND DEPOSIT AGREEMENT.

CONTACT INFORMATION

If you have questions or concerns regarding the proper use of this tool, please contact your Verco or Vulcraft Customer Service Representative.

Verco Decking, Inc.
Customer Service
(602) 272-1347

Vulcraft
Customer Service
(256) 845-2460

PUNCHLOK® II SYSTEM TERRITORY MAP

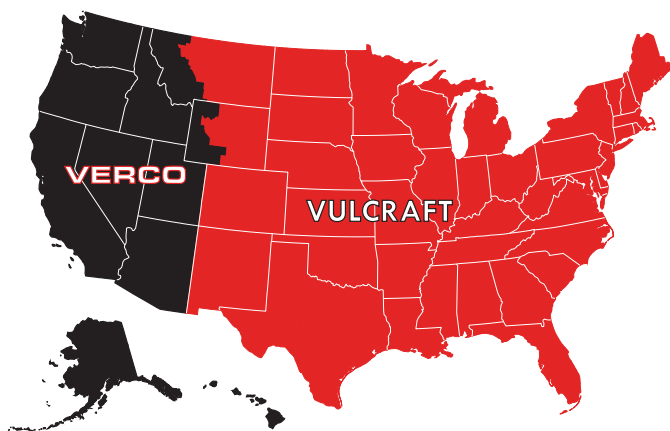

The PunchLok II tool is the subject of U.S. Patent Nos. 6,212,932 and 8,667,656. VERCO® and PUNCHLOK® are registered trademarks of Verco Decking, Inc. VULCRAFT® is a registered trademark of NUCOR Corporation. PLB™, PLN3™, PLN™, and FORMLOK™ are trademarks of Verco Decking, Inc. 1.5PLB™, 3.0PLN™, 1.5PLVLI™, 2.0PLVLI™, and 3.0PLVLI™ are trademarks of NUCOR Corporation.

PunchLok[®] II

S Y S T E M



NUCOR[®]
VULCRAFT/VERCO